

Article number: 20055558

Description: E+G Quick-fit coupling (radial displacement)  
GN 240-M20x1,5-B

## Measures

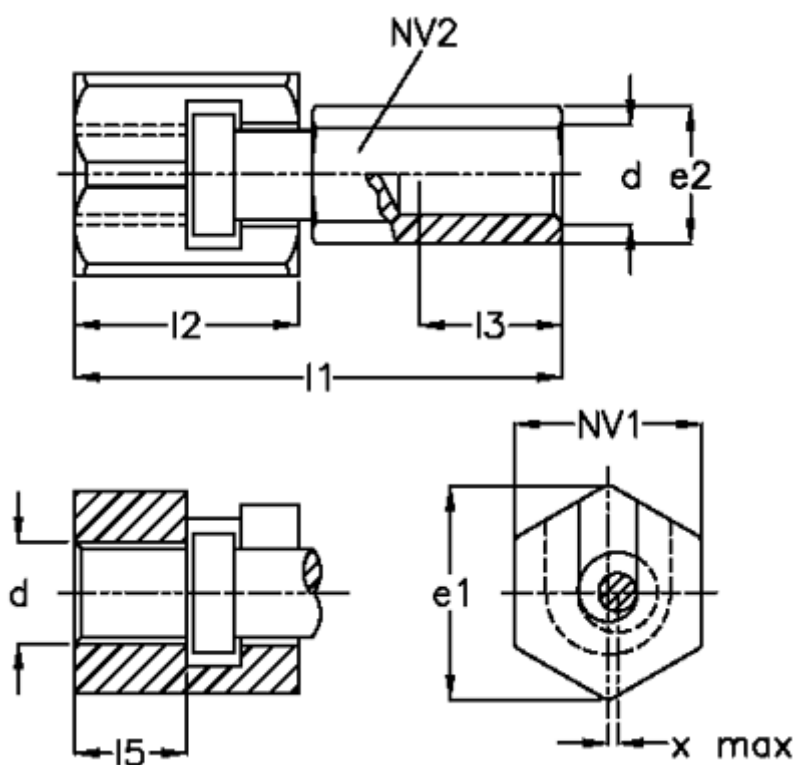

d	= M 20x1,5	Max push-pull strength N = 30000
e1	= 44.0	NV 1 = 41
e2	= 34.0	NV 2 = 30
l1	= 93.5	
l2	= 45.5	
l3	= 29.0	
l5 +1	= 23.5	
Max displacement	= 1.0	